



MERKMALE:

Abluftgitter mit 45° geneigten festen Lamellen, Abstand 25 mm.

AUSFÜHRUNG:

Eloxiertes Aluminium.

EINSATZBEREICH:

An der Wand, für Rückluft.

BEFESTIGUNG:

- Standardbefestigung mit Clips.
- Schraubbohrungen auf Anfrage.
- Magnet auf Anfrage (CL).
- Klemmen auf Anfrage (KC).

ZUBEHÖR:

- Anschlusskasten aus verzinktem Stahl, Standard oder isoliert.
- Jalousieklappe aus verzinktem Stahl, mit Lamellen mit gegensätzlichen Bewegungen.
- Montagerahmen aus verzinktem Stahlblech.

CHARACTERISTICS:

Return grilles with fixed and 45° inlined bars 25 mm pitch.

CONSTRUCTION:

Anodized aluminium.

UTILIZATION:

For wall installation and for air intake.

FIXING:

- Standard fixing by clips.
- Holes for screws upon request.
- Magnets on request (CL).
- Lock upon request (KC).

ACCESSORIES:

- Galvanized steel plenum, standard or insulated.
- Calibration damper made of galvanized steel and fins with opposite movement.
- Mounting counterframes made of galvanized steel sheet.





PREISE - PRICES

LAGERND

BxH	GRA	GRAR	GRARZ	GRARSS	SC	CT CTKC	PBZ1	PBZ11	PBZ2	PBZ12
mm	€	€	€	€	€	€	€	€	€	€
200x100	11,37	14,35	15,79	34,69	8,80	4,95	21,89	31,77	22,16	32,17
300x100	13,17	16,75	18,43	38,28	9,43	4,95	23,08	33,58	23,42	34,11
400x100	16,15	19,74	21,72	43,68	10,04	5,50	30,41	41,86	25,73	37,69
500x100	19,16	22,14	24,36	49,66	12,24	6,05	31,57	43,67	27,20	39,95
• 600x100	21,54	25,73	28,30	54,44	13,83	6,61	32,75	45,47	28,65	42,20
• 800x100	26,33	31,71	34,88	64,01	17,88	7,92	35,09	49,09	33,49	49,66
• 1000x100	34,11	37,71	41,48	74,51	21,84	9,03	43,85	59,44	37,07	55,08
• 1200x100	38,90	44,88	49,36	84,97	26,38	12,11	55,18	72,50	49,40	69,68
200x150	13,76	16,15	17,77	38,90	9,43	4,95	22,84	33,10	23,14	33,56
300x150	15,56	19,74	21,72	44,88	10,68	5,50	24,12	35,06	25,45	37,14
400x150	18,54	20,95	23,05	50,26	12,56	6,05	25,39	37,03	27,03	39,56
500x150	22,74	25,12	27,63	56,84	14,44	7,26	32,83	45,47	29,97	44,12
• 600x150	26,92	30,51	33,57	62,22	16,34	7,92	34,11	47,44	31,74	46,85
• 800x150	31,71	37,71	41,48	74,79	20,72	9,03	45,65	60,83	44,29	61,79
• 1000x150	36,49	44,27	48,69	84,97	24,71	10,24	54,61	71,50	50,50	71,27
• 1200x150	43,68	52,06	57,26	95,14	27,96	12,65	57,16	75,43	54,49	77,40
200x200	14,97	18,54	20,39	44,27	10,04	5,50	23,77	34,41	24,97	36,28
300x200	18,54	21,54	23,69	49,66	13,83	6,05	25,15	36,55	26,64	38,85
400x200	20,34	23,93	26,32	55,05	15,07	6,99	26,52	38,68	29,59	43,40
500x200	25,73	33,44	36,77	64,63	17,59	7,92	27,90	40,80	31,46	46,30
• 600x200	32,91	40,70	44,76	69,41	20,11	8,49	44,70	59,12	42,59	58,92
• 800x200	37,71	44,27	48,69	84,97	24,51	10,24	47,46	63,37	48,46	67,97
• 1000x200	44,27	52,64	57,92	97,52	27,02	11,44	50,22	67,63	55,17	78,32
• 1200x200	50,26	59,24	65,16	111,29	29,52	13,21	59,72	83,70	66,51	97,23
200x300	18,54	21,54	23,69	52,06	13,83	6,05	25,15	36,55	26,64	38,85
300x300	22,74	26,92	29,61	59,84	16,34	7,26	26,99	39,26	30,04	43,98
400x300	27,53	33,51	36,86	68,81	20,11	8,49	38,30	51,93	41,86	57,43
500x300	34,11	40,08	44,09	61,64	22,00	9,68	39,89	54,38	45,65	63,26
• 600x300	40,70	49,66	54,63	89,74	23,88	10,24	47,64	63,30	47,94	66,81
• 800x300	49,66	59,84	65,82	108,90	28,91	12,11	57,57	80,03	61,61	89,30
• 1000x300	59,84	71,79	78,97	126,25	34,56	13,76	61,25	85,45	69,86	101,78
• 1200x300	70,61	84,35	92,80	144,20	40,21	14,98	71,17	95,07	82,02	114,90
200x400	20,95	25,12	27,63	59,84	15,07	6,99	26,52	38,68	29,59	43,40
300x400	28,71	34,69	38,17	72,39	20,11	8,49	38,30	51,93	41,86	57,43
400x400	37,10	44,27	48,69	85,56	22,51	9,68	40,60	55,22	46,35	64,11
500x400	44,27	52,64	57,92	98,13	27,33	10,78	42,39	57,99	50,75	70,92
• 600x400	50,26	60,42	66,47	108,90	28,91	12,11	57,11	79,05	60,23	86,91
• 800x400	64,01	76,60	84,25	133,43	35,19	13,76	67,44	91,70	74,93	106,30
• 1000x400	72,51	91,54	100,70	155,56	41,46	15,62	80,04	109,04	92,72	131,68
• 1200x400	88,56	106,51	117,16	177,10	49,63	16,72	83,63	114,60	98,98	141,36
200x500	26,92	32,30	35,55	70,61	17,59	7,92	27,90	40,80	31,46	46,30
300x500	35,30	42,48	46,74	85,56	22,00	9,68	39,89	54,38	45,65	63,26
400x500	46,07	55,64	61,19	101,72	27,33	10,78	42,39	57,99	50,75	70,92
500x500	50,86	61,64	67,80	113,08	33,91	12,11	51,15	72,90	60,42	87,24
• 600x500	59,84	71,79	78,97	127,45	35,19	13,21	53,15	76,00	65,68	95,34

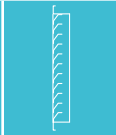
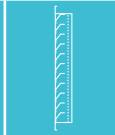
• Zwischenverstärkung - Intermediate reinforcing

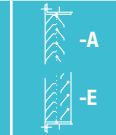
PREISE - PRICES

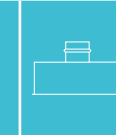
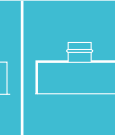
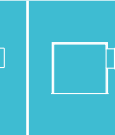
										
BxH	GRA	GRAR	GRARZ	GRARSS	SC	CT CTKC	PBZ1	PBZ11	PBZ2	PBZ12
mm	€	€	€	€	€	€	€	€	€	€
• 800x500	75,99	91,54	100,70	154,37	41,46	15,08	79,07	107,57	90,42	128,14
• 1000x500	91,54	110,08	121,10	183,67	52,15	16,85	83,10	113,77	96,97	135,20
• 1200x500	110,08	132,24	145,46	215,39	60,95	18,61	87,10	119,95	102,81	144,23
200x600	34,11	41,29	45,41	78,99	20,11	8,49	44,70	59,12	42,59	58,92
300x600	42,48	52,06	57,26	98,72	23,88	10,24	47,64	63,30	47,94	66,81
400x600	52,06	62,22	68,45	114,88	28,91	12,11	57,11	79,05	60,23	86,91
500x600	61,03	72,99	80,29	131,03	35,19	13,21	53,15	76,00	65,68	95,34
• 600x600	70,61	84,35	92,80	146,60	40,21	14,41	71,10	98,31	84,76	119,39
• 800x600	88,56	107,10	117,81	178,89	48,98	16,18	81,71	111,63	94,38	134,26
• 1000x600	110,08	132,24	145,46	214,19	60,94	18,71	86,13	118,48	104,29	146,52
• 1200x600	124,45	149,58	164,54	242,33	72,24	20,36	90,57	125,31	110,98	156,83
200x800	38,90	46,66	51,33	97,52	24,51	10,24	47,46	63,37	48,46	67,97
300x800	52,06	62,83	69,12	117,86	28,91	12,11	57,57	80,03	61,61	89,30
400x800	69,41	84,97	93,46	139,40	35,19	13,76	67,44	91,70	74,93	106,30
500x800	77,79	96,34	105,97	160,96	41,46	15,08	79,07	107,57	90,42	128,14
• 600x800	90,95	111,88	123,08	182,49	48,98	16,18	81,71	111,63	94,38	134,26
• 800x800	113,08	135,81	149,40	225,57	76,01	18,71	86,98	119,76	105,12	147,80
• 1000x800	141,19	169,92	186,90	269,85	81,68	21,03	92,24	127,89	116,43	165,26
• 1200x800	163,95	196,84	216,53	309,93	98,00	23,33	97,50	136,02	124,36	177,52
Außenmaß mit Rahmen 595x595 mm. overall size	60,58	72,38	79,62	128,32	40,21	14,41	53,62	76,73	66,37	96,42

Preis auf Anfrage für nicht in der Tabelle erwähnten Abmessungen - - For bigger sizes prices on request

• Zwischenverstärkung - Intermediate reinforcing

LACKIERUNG - PAINTING:

Farben RAL 9010 - 9016: + 15% - Colour RAL 9010 - 9016: + 15%

Weitere Farben auf Anfrage - Different colors prices on request

BESCHREIBUNGEN - DESCRIPTIONS:

GRA: Abluftgitter Abstand 25 mm - Return grille (25 mm between bars)

GRAR: Abluftgitter, Abstand 25 mm mit Vogelschutzgitter - Return grille (25 mm between bars) with bird mesh

GRARZ: Abluftgitter, Abstand 25 mm mit Insektenschutzgitter - Return grille (25 mm between bars) with insect screen.

GRARSSA: Abluftgitter, Abstand 25 mm mit Vogelschutzgitter und Schwerkraft-Überdruckklappe (Ansaugung) - Return grille (25 mm between bars) with bird mesh and overpressure damper (aspiration)

GRARSSSE: Abluftgitter, Abstand 25 mm mit Vogelschutzgitter und Schwerkraft-Überdruckklappe (Ausstoß) - Return grille (25 mm between bars) with bird mesh and overpressure damper (expulsion)

AUSFÜHRUNGEN AUF ANFRAGE - AVAILABLE ON REQUEST:

Komplettes Abluftgitter mit Regenschutz +TEG +5% - Grille with rain-proof panel +TEG +5% INCREASE

ZUBEHÖR - ACCESSORIES:

SC: Jalousieklappe mit gegenläufig bewegten Lamellen - Opposed blade damper

CT: Montagerahmen aus verzinktem Stahlblech - Counterframes in galvanised steel sheet profile section

CTKC: Montagerahmen aus verzinktem Stahl für Klemmen KC - Counterframe in galvanised steel for clamps KC

PBZ: Anschlusskasten - Connecting plenum



ZEICHNUNGEN - DRAWINGS

GRI

GRA

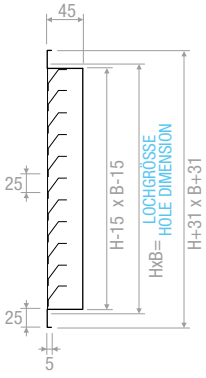

GRA + SC

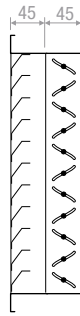

GRAR

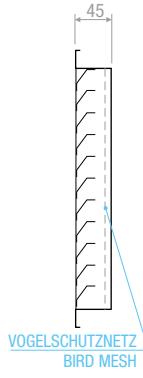

GRARZ

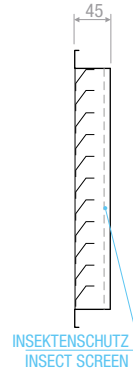

GRARSS

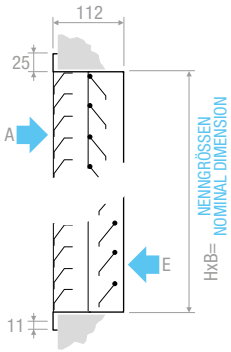

GRA 595x595

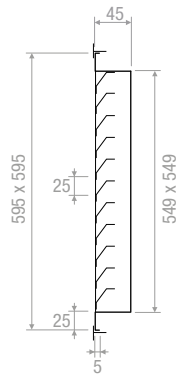

CT



CTKC

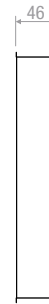

GRA + TEG

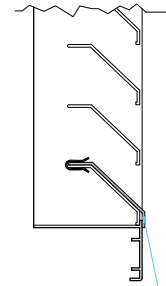

REGENSCHUTZ PREIS +5%
RAIN LIP PRICE INCREASE 5%

BEFESTIGUNG - TYPE OF FIXING

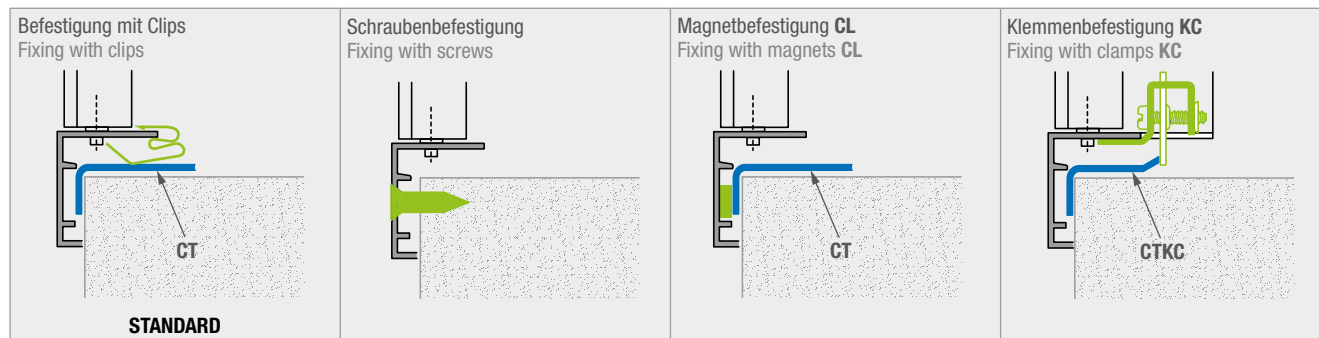

CL: 1,00 € je Stück - each
Jedes Abluftgitter - Each grill 8 CL

KC: 4,00 € je Stück - each
von - from 200x100 bis - to 1000x300: 2 KC
von - from 400x400 bis - to 1000x500: 4 KC

BOHRUNGEN - HOLE

2 Bohrungen - Holes

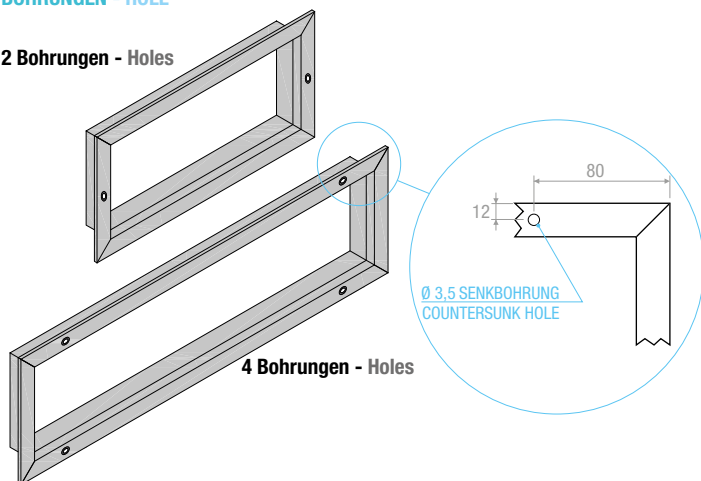

Anzahl der Bohrungen für Befestigungsschrauben Amount of holes for mounting screw					
Kürzere Seite Smaller side	Längere Seite - Longer side				
	200	250	300	350	≥400
100	2	2	2	4	4
150	2	2	2	4	4
200	2	2	2	4	4
≥250	2	2	2	4	4

ZEICHNUNGEN - DRAWINGS

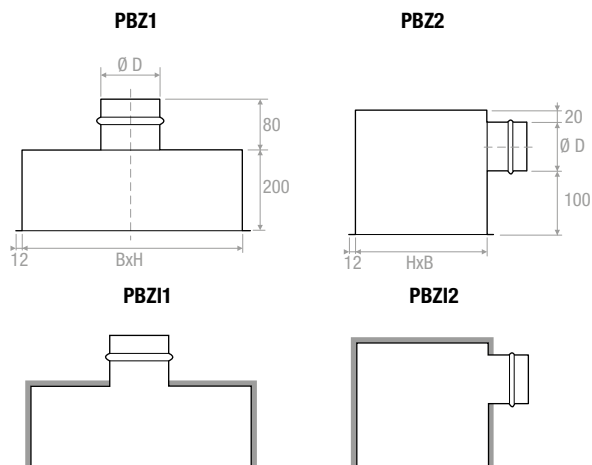

Anschlusskasten mit 6 mm Außenisolierung
Plenum externally insulated thickness 6 mm



SCHNELLAUSLEGUNG - QUICK SELECTION DIAGRAM

GRI

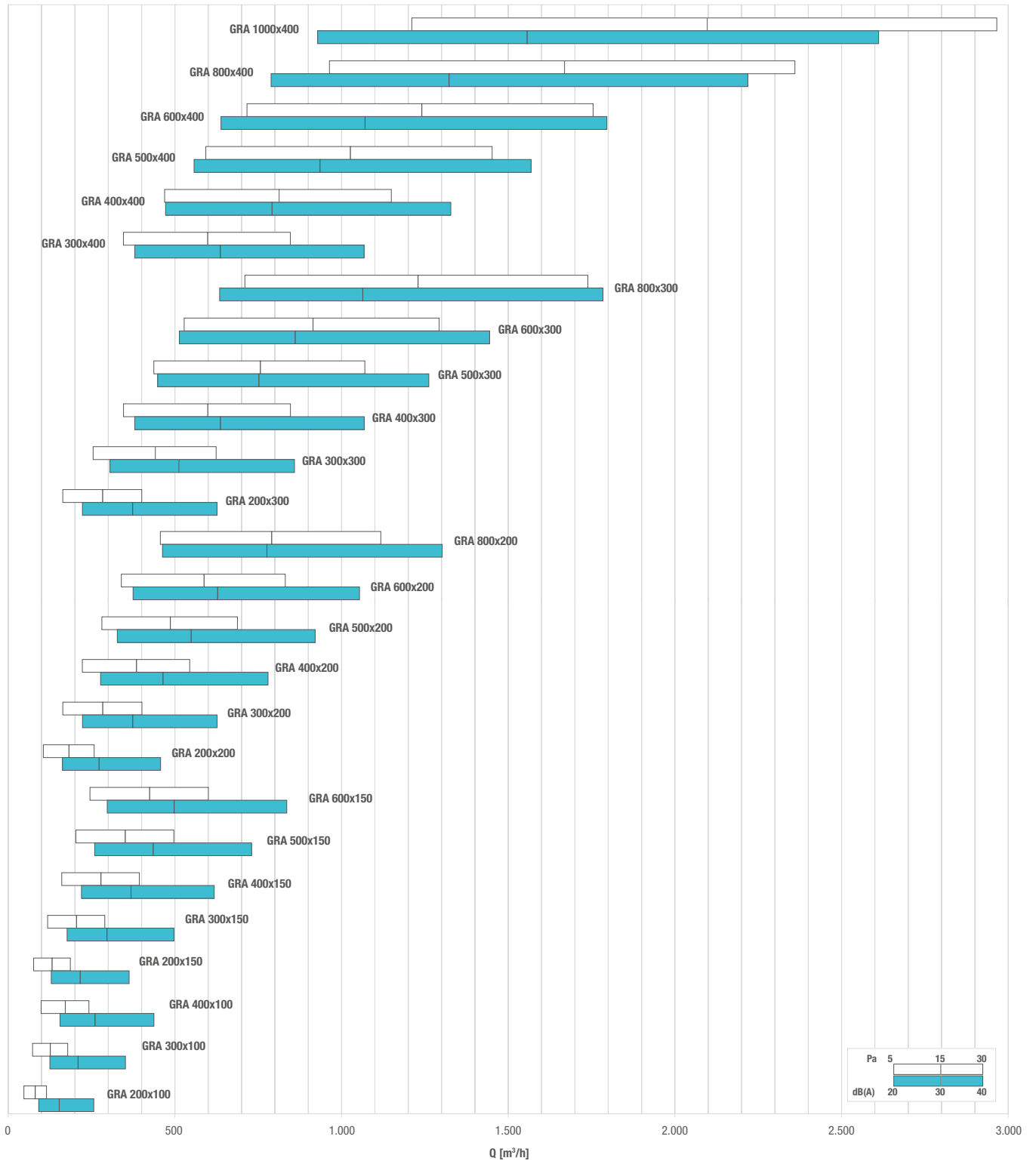

AUSWAHLTABELLE - SELECTION TABLE

Modell - Model	A _k [m ²]	Q [m ³ /h]		L _{wa} [dB(A)]		Dp _t [Pa]	
		min	max	min	max	min	max
GRA 200x100	0,0101	50	120	-	25	5	30
GRA 300x100	0,0157	70	180	-	27	5	30
GRA 400x100	0,0213	100	240	-	28	5	30
GRA 500x100	0,0269	120	310	-	30	5	30
GRA 600x100	0,0325	150	370	-	31	5	30
GRA 800x100	0,0437	200	500	-	33	5	30
GRA 1000x100	0,0548	250	620	-	34	5	30
GRA 1200x100	0,0660	310	750	-	35	5	30
GRA 200x150	0,0164	80	190	-	27	5	30
GRA 300x150	0,0255	120	290	-	30	5	30
GRA 400x150	0,0346	160	390	-	31	5	30
GRA 500x150	0,0437	200	500	-	33	5	30
GRA 600x150	0,0528	250	600	-	34	5	30
GRA 800x150	0,0709	330	810	-	35	5	30
GRA 1000x150	0,0891	410	1010	-	36	5	30
GRA 1200x150	0,1073	500	1220	20	38	5	30
GRA 200x200	0,0227	110	260	-	29	5	30
GRA 300x200	0,0353	160	400	-	31	5	30
GRA 400x200	0,0478	220	540	-	33	5	30
GRA 500x200	0,0604	280	690	-	34	5	30
GRA 600x200	0,0730	340	830	-	35	5	30
GRA 800x200	0,0982	460	1120	-	37	5	30
GRA 1000x200	0,1234	570	1400	21	38	5	30
GRA 1200x200	0,1486	690	1690	22	39	5	30
GRA 200x300	0,0352	160	400	-	31	5	30
GRA 300x300	0,0548	250	620	-	34	5	30
GRA 400x300	0,0744	350	850	-	36	5	30
GRA 500x300	0,0940	440	1070	-	37	5	30
GRA 600x300	0,1136	530	1290	21	38	5	30
GRA 800x300	0,1528	710	1740	22	40	5	30
GRA 1000x300	0,1920	890	2190	23	41	5	30
GRA 1200x300	0,2312	1070	2630	24	42	5	30
GRA 200x400	0,0478	220	540	-	33	5	30
GRA 300x400	0,0744	350	850	-	36	5	30
GRA 400x400	0,1010	470	1150	-	37	5	30
GRA 500x400	0,1276	590	1450	21	38	5	30
GRA 600x400	0,1542	720	1750	22	39	5	30
GRA 800x400	0,2073	960	2360	24	41	5	30
GRA 1000x400	0,2605	1210	2970	25	42	5	30
GRA 1200x400	0,3137	1460	3570	26	43	5	30
GRA 200x500	0,0603	280	690	-	34	5	30
GRA 300x500	0,0939	440	1070	-	37	5	30
GRA 400x500	0,1275	590	1450	21	38	5	30
GRA 500x500	0,1611	750	1830	23	40	5	30
GRA 600x500	0,1947	900	2220	23	41	5	30
GRA 800x500	0,2619	1220	2980	25	42	5	30
GRA 1000x500	0,3291	1530	3750	26	44	5	30
GRA 1200x500	0,3963	1840	4510	27	45	5	30
GRA 200x600	0,0729	340	830	-	35	5	30
GRA 300x600	0,1135	530	1290	21	38	5	30
GRA 400x600	0,1541	720	1750	22	40	5	30
GRA 500x600	0,1947	900	2220	23	41	5	30
GRA 600x600	0,2353	1090	2680	25	42	5	30
GRA 800x600	0,3165	1470	3600	26	44	5	30
GRA 1000x600	0,3977	1850	4530	28	45	5	30
GRA 1200x600	0,4789	2230	5450	29	46	5	30
GRA 200x800	0,0980	460	1120	-	37	5	30
GRA 300x800	0,1526	710	1740	22	40	5	30
GRA 400x800	0,2072	960	2360	24	41	5	30
GRA 500x800	0,2618	1220	2980	25	42	5	30
GRA 600x800	0,3164	1470	3600	26	44	5	30
GRA 800x800	0,4256	1980	4850	28	45	5	30
GRA 1000x800	0,5348	2490	6090	29	46	5	30
GRA 1200x800	0,6440	2990	7330	30	47	5	30
GRA 595x595	0,1957	910	2230	24	41	5	30

