

**MERKMALE:**

Plenum in Set-Version für Luftdurchlass auf Platte.

AUSFÜHRUNG:

Geformtes Polystyrol Dichte 45 kg/mc, Brandschutzklasse 1 und innen kristallisiert.

BEFESTIGUNG:

Befestigung am Luftdurchlass des Plenums mittels Schraube am Balken "A"

ZUBEHÖR:

Befestigungsstange, flexibler Schlauchanschluss, Dämpfer, Ausgleicher.

CHARACTERISTICS:

Plenum kit version for diffuser on panel.

CONSTRUCTION:

Polystyrene printed density 45 kg/mc, flame retardant class 1 and crystallized on the inside.









FIXING:

Attaching the diffuser of the plenum through the screw on the bar "A".

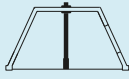
ACCESSORIES:

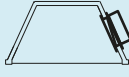
Fixing rod, connection for flexible duct, damper, equalizer.

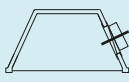
PREISE - PRICES

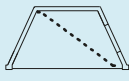
Code - Code	Beschreibung - Description			mm	€
BPPSK	Plenum in Set-Version Plenum kit version				39,69
KITFISSPESP	Plenum/Luftdurchlass Befestigungsstange Fixing rod plenum/diffuser				7,64
BCANPL	Schlauchanschluss Connection for flexible hose			125	9,45
				160	10,75
				200	11,05
				250	12,01
BS	Klappe Damper			125	3,40
				160	3,40
				200	4,33
				250	5,54
BEPS	Equalizer Equalizer				12,56

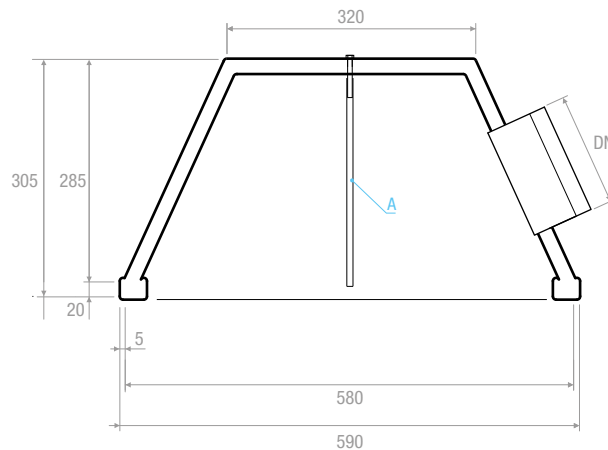
ZEICHNUNGEN - DRAWINGS

NICHT MONTIERTES MATERIAL ZUR MONTAGE AM BAUPLATZ
MATERIAL SUPPLIED LOOSE TO BE ASSEMBLED ON SITE