



MERKMALE:

Die Zentrifugaldachventilatoren der Serie TCO-Serie bestehen aus pulverlackiertem Eisenblech mit einem Rad aus verzinktem Stahl.

Diese stellen eine maximal funktionale und geräuschlose Lösung für kleine und mittlere Luftabsauganlagen dar. Die große Einfachheit der Installation bevorzugt deren Anwendung bei allen Gelegenheiten, in denen keine staubige Luft abgesaugt werden muss.

CHARACTERISTICS:

The centrifugal roof fans TCO series are made of iron sheet powder-coated with galvanized steel impeller. They represent a solution with maximum functionality low noise level for small and medium air extraction systems. The great simplicity of installation emphasizes their application in all intake air plants with not dusty air.

ALLGEMEINE TECHNISCHE DATEN - PREISE - GENERAL TECHNICAL DATA TABLE - PRICES

LAGERND

MODELL MODEL	SPANNUNG VOLTAGE	FREQUENZ FREQUENCY	LEISTUNG POWER	STROM CURRENT	REGLER CONTROL	GESCHWINDIG- KEIT SPEED	
	V	Hz	W	A		RPM	€
TCO 225	230	50	130	0,6	RC2A	2624	250,01
TCO 250	230	50	120	0,8	RC2A	2685	274,08
TCO 315	230	50	180	0,6	RC2A	1400	425,94
TCO 355	230	50	220	1,1	RC2A	1400	564,83
TCO 400	230	50	345	1,5	RC2A	1400	962,99
TCO 450	230	50	620	2,8	RC5A	1400	1.166,70

ABMESSUNGEN - DIMENSIONAL TABLE

Modell - Model	A	B	C	D	E	F	G
TCO 225	336	386	105	212	274	146	35
TCO 250	370	386	105	225	290	163	35
TCO 315	454	443	135	293	333	185	40
TCO 355	595	595	135	285	450	234	40
TCO 400	595	685	145	355	450	270	40
TCO 450	664	685	145	400	450	282	40

ZEICHNUNGEN - DRAWINGS

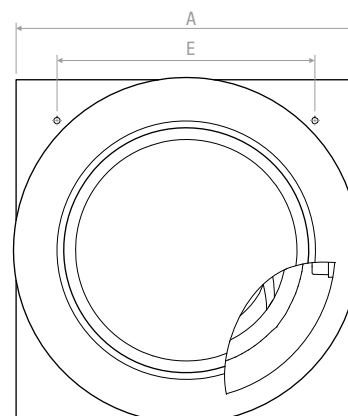
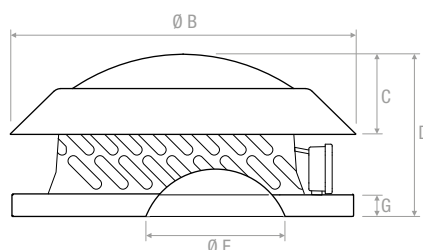

MODELL MODEL	€
RC2A	44,20
RC5A	53,04



LEISTUNGSDATEN - PERFORMANCE TABLE

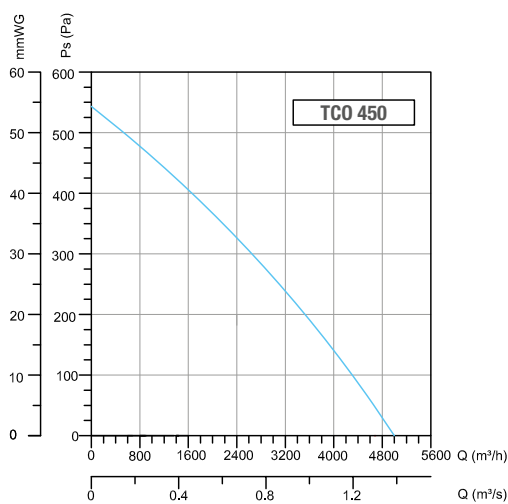
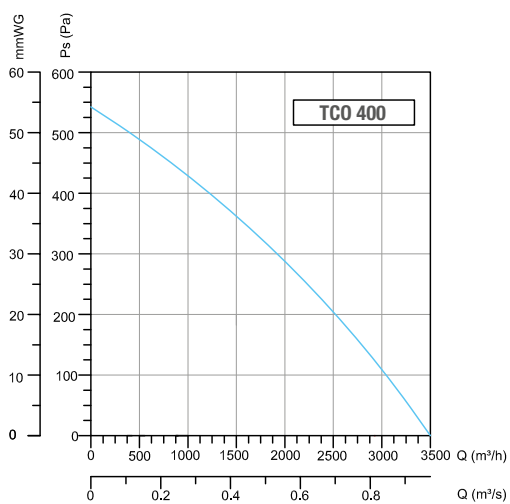
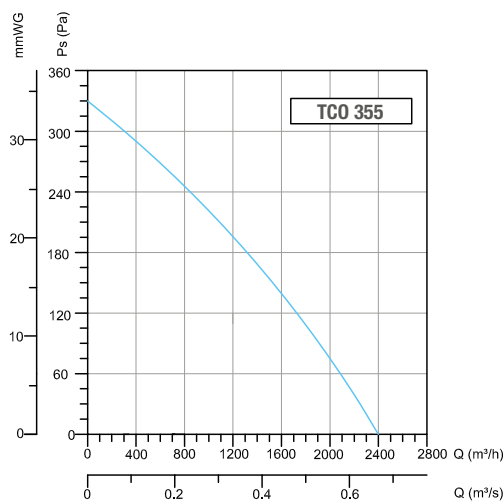
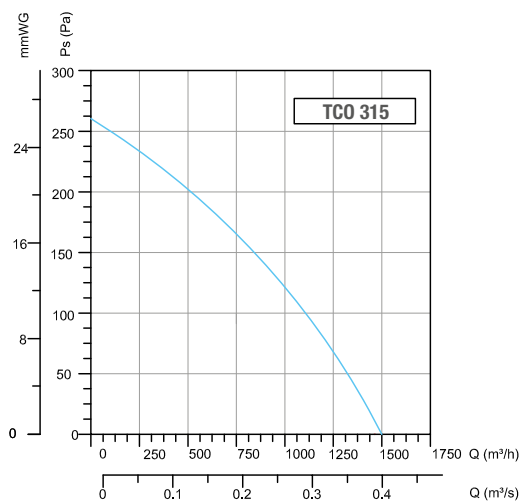
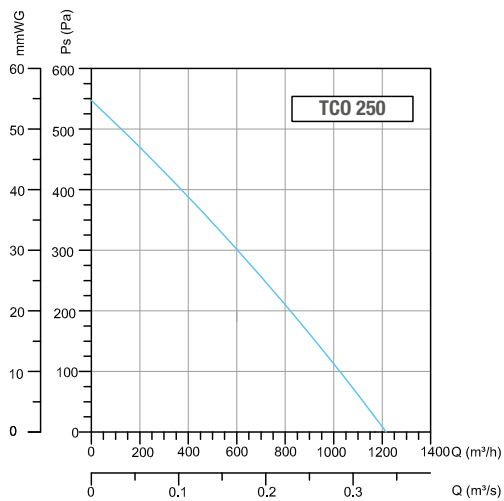
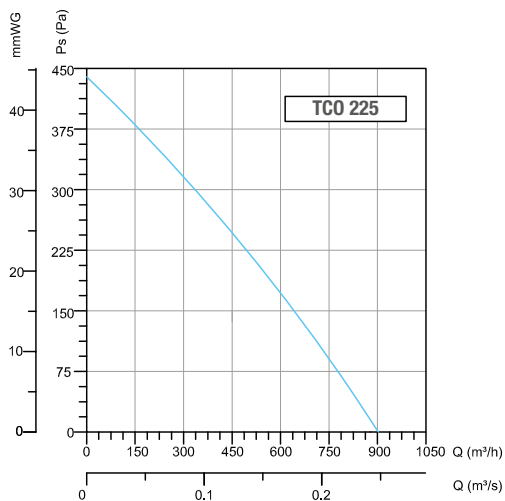

EN