



MERKMALE:

Die Radialventilatoren in Linie der VCC-Serie sind gemacht mit einem Blechkasten aus pulverbeschichtetem Eisen und Laufrad aus verzinktem Stahl. Der Elektromotor direkt gekoppelt ist direkt vom gekühlt Flüssigkeit gefördert. diese Ventilatoren sind geeignet in irgendeinem arbeiten Position mit dem Großen Vorteil zu tragen die Luft auf derselben Achse wie der Laufrad. Beide Seiten des Lüfters sind bereit für die Verbindung zu Kanälen mit Schnellkupplung.

CHARACTERISTICS:

In-line centrifugal fans of the series VCC are made with housing in powder-coated sheet iron and galvanized steel impeller. The electric motor is directly coupled and cooled by the air flow. This range of fans is suitable for work in any position with the great advantage of being able to move the air on the same axis of the impeller. Both sides of the fan are designed to connect the ducts with fastening clamps.

ALLGEMEINE TECHNISCHE DATEN - PREISE - GENERAL TECHNICAL DATA TABLE - PRICES

LAGERND

MODELL MODEL	SPANNUNG - VOLTAGE	FREQUENZ FREQUENCY	LEISTUNG - POWER	ISOLIERKLASSE INSULATION CLASS	STROM - CURRENT	REGLER CONTROL	GESCHWINDIGKEIT SPEED	
	V	Hz	W	class	A		RPM	€
VCC 100	230	50	80	IP 55	0,3	RC2A	2610	111,11
VCC 125	230	50	80	IP 55	0,36	RC2A	2325	114,82
VCC 150 B	230	50	85	IP 55	0,38	RC2A	2425	124,08
VCC 160 A	230	50	90	IP 55	0,4	RC2A	2385	124,08
VCC 200 A	230	50	95	IP 55	0,43	RC2A	2280	153,71
VCC 200 B	230	50	122	IP 55	0,56	RC2A	2550	166,67
VCC 250 A	230	50	124	IP 55	0,56	RC2A	2500	187,04
VCC 250 B	230	50	145	IP 55	0,63	RC2A	2635	196,30
VCC 315 A	230	50	190	IP 55	0,9	RC2A	2560	227,78
VCC 315 B	230	50	210	IP 55	1,1	RC2A	2660	238,90
VCC 355	230	50	123	IP 55	0,63	RC2A	1420	351,86

MODELL MODEL	€
RC2A	44,20



ZEICHNUNGEN - DRAWINGS

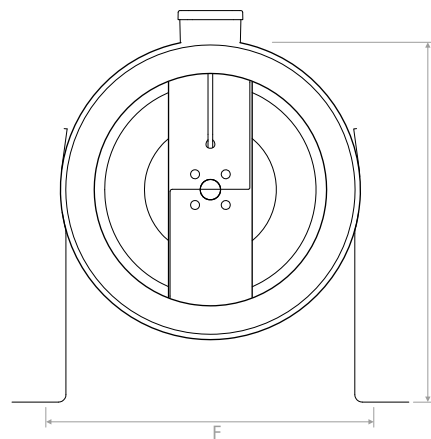
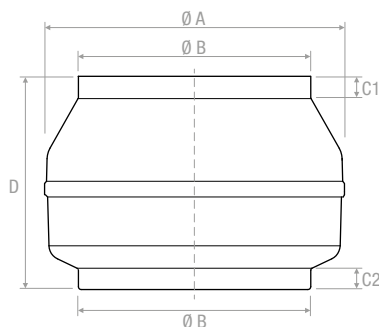

ABMESSUNGEN - DIMENSIONAL TABLE

Modell - Model	A	B	C1	C2	D	E	F
VCC 100	245	97	22	22	197	273	268
VCC 125	245	122	20	20	188	273	268
VCC 150 B	272	147	23	25	192	286	295
VCC 160 A	272	157	23	25	192	286	295
VCC 200 A	330	196	30	28	230	380	352
VCC 200 B	330	196	30	28	230	380	352
VCC 250 A	330	247	30	28	227	380	352
VCC 250 B	330	247	30	28	227	380	352
VCC 315 A	400	313	30	30	285	415	422
VCC 315 B	400	313	30	30	285	415	422
VCC 355	400	352	30	30	378	415	422

LEISTUNGSDATEN - PERFORMANCE TABLE

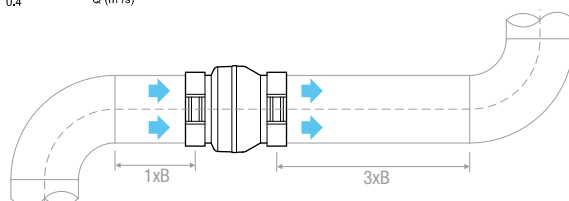
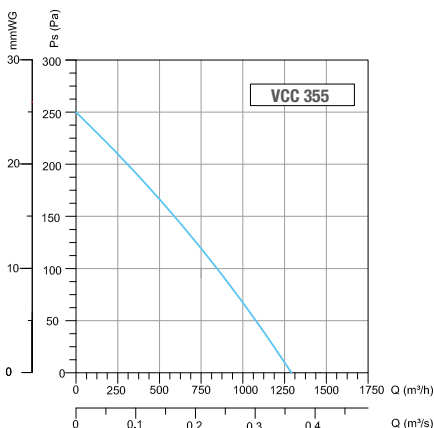
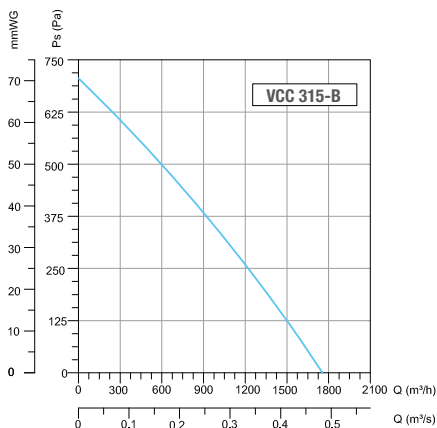
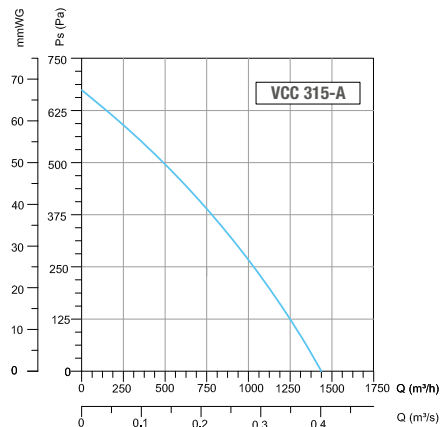
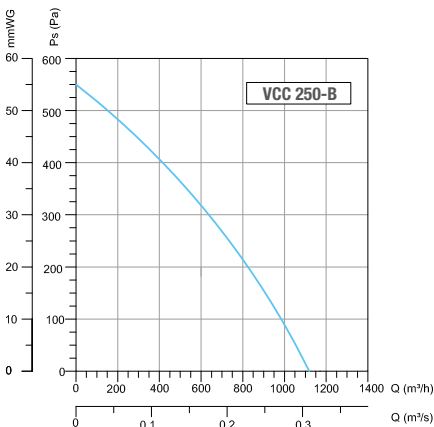
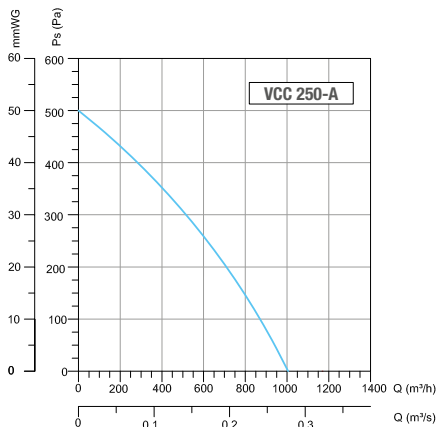
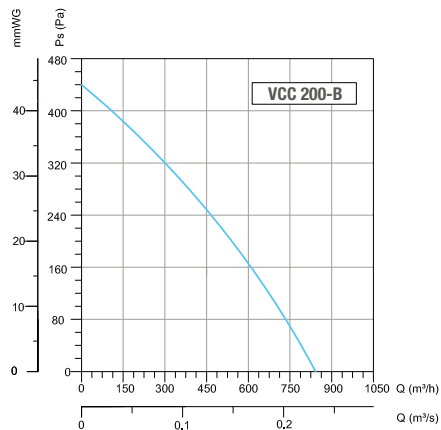
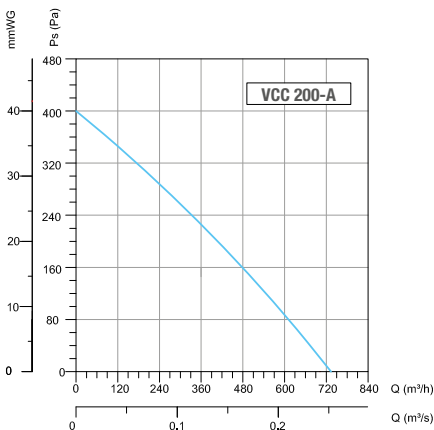
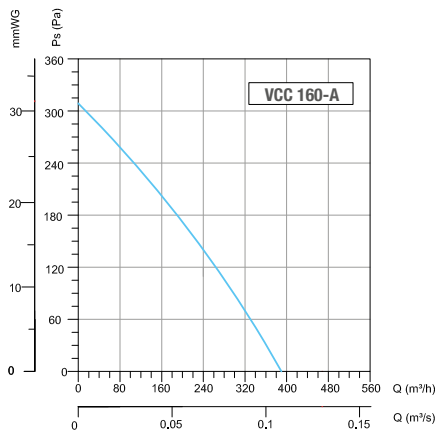
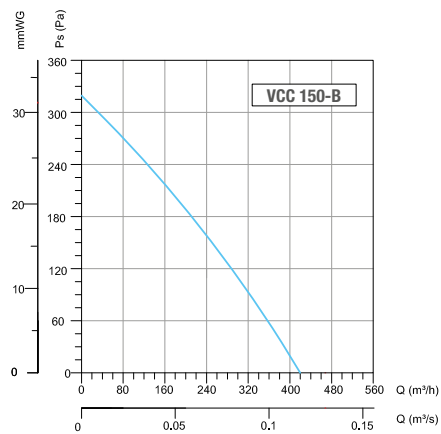
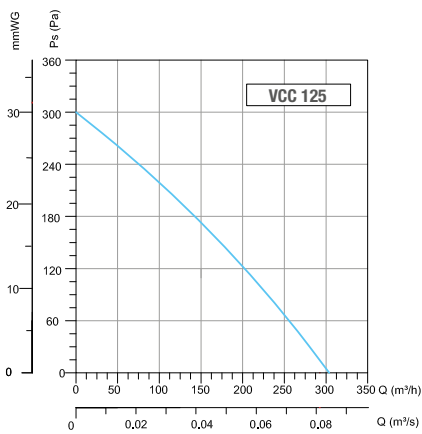
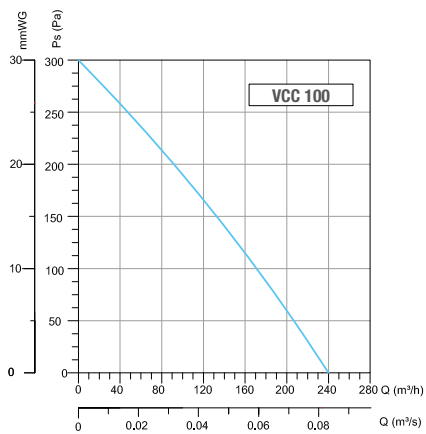

EN